



The Road to eDNA

eInvoicing portfolio of xSuite Group GmbH



Peppol: Future of Belgium Invoicing

- Obligation in 01/2026
- Bing-Bang Approach for E-Invoicing mandate
- Obligation for sending and receiving
- Peppol will be the standard
- Directive 2014/55/EU defines the format (Peppol BIS – Billing Invoices)
- Mercurius and Hermes as transition Platforms

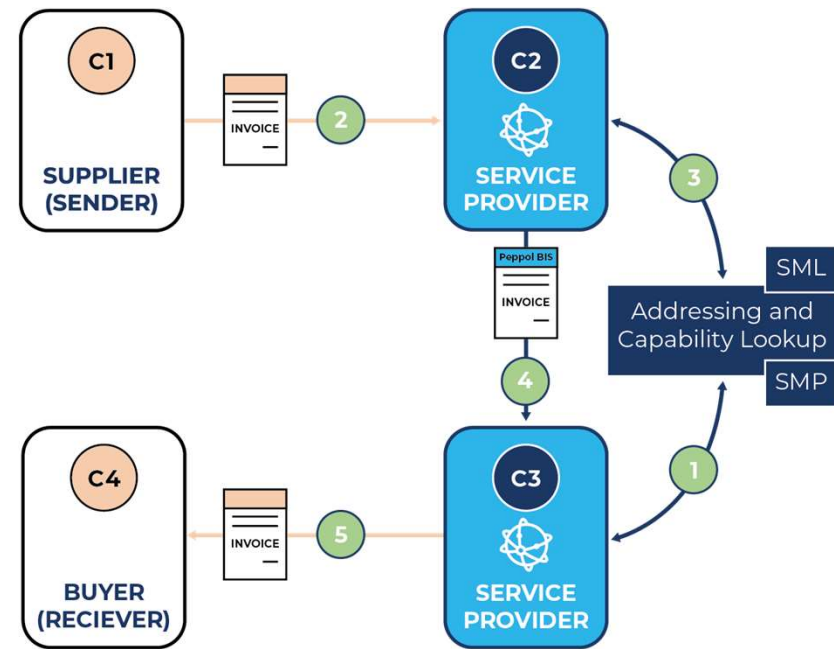

Peppol 4 – Corner Modell



Status Quo Europe?

Poland

- B2B Verpflichtung Juli 2024 - delayed

Rumania

- B2G since 2022 mandantory
- B2B in Juli 2024

Slovakia

- B2B E-Rechnung in 2025

Spain

- B2B E-Rechnung in 2025

Belgium

- B2B E-Rechnung in 2026 with Peppol

France

- B2B E-Invoicing & E-Reporting in September 2026

Role of Peppol ?

- Standardized and interoperable platform
- Compliance with the e-invoicing obligation in several countries

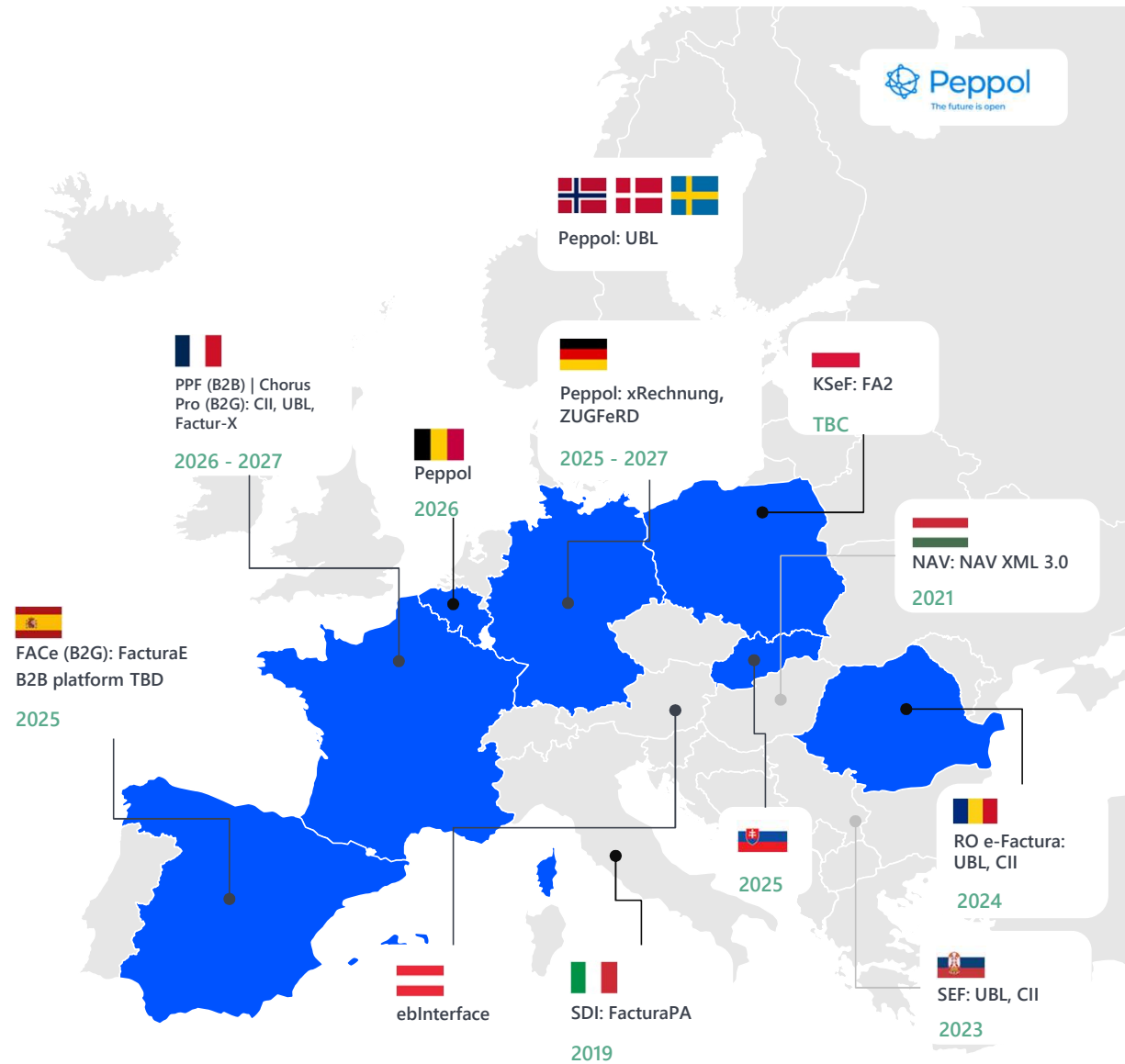

E-invoicing international

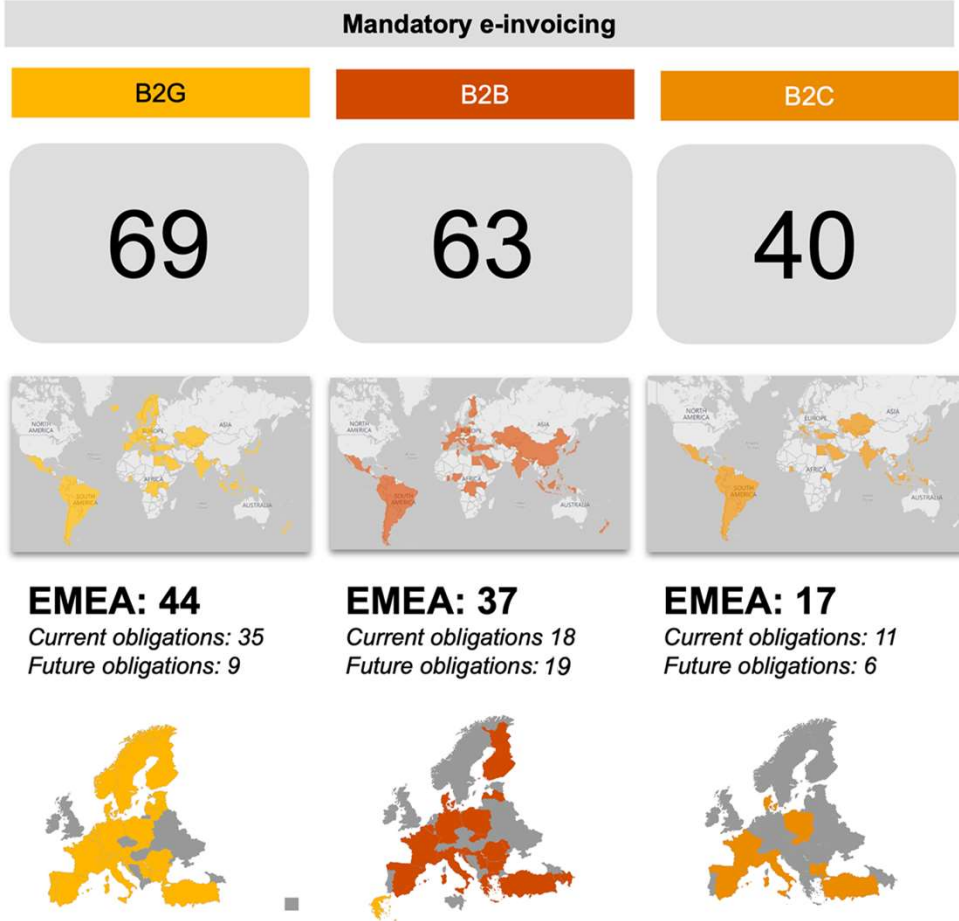

Source: PwC

Electronic invoices

cube 

Cube GmbH
Kubus-Allee 234
20097 Hamburg
Contact: Annette Fieger
Tel: +49 (0) 40 55 66 36 -0
Fax: +49 (0) 40 55 66 38 - 12
Executive Board: Hubertus Kubicki,
Hermann Maier
info@cube.de | www.cubealibaba.de

Cube GmbH – Kubus-Allee 234 – 20097 Hamburg
Invoice-No.: 0070223
Customer-No.: 102708
Invoice Date: 06.12.2023
Order No.: 236514

xSuite Group GmbH
Hamburger Str. 12
22926 Altrosenburg

INVOICE 00412023
Dear Mrs. Wilms,
Thank you for your order. For the ordered items we take the liberty of calculating the following prices:

Pos.	Description	Quantity	Unit price	Total Net Amount
1	CLEARTEXT Endreinschutzmatte BKX119 FC	3	65,00 €	195,00 €
2	BKX19 PAVO Folie	16	3,14 €	50,24 €
3	Lerema Folie PP 30mm Pink	10	2,27 €	22,70 €
4	BKX19 PAVO Paper A4 5kg	100	2,26 €	226,00 €
5	BKX19 PAVO Bag A4 5kg	4	15,97 €	63,88 €
6	Tray 1308 Pick-up/Bahn-Abweiser	2	15,20 €	30,40 €
Total (incl. VAT):				669,22 €
VAT (19.0% Net):				127,14 €
Total (incl. VAT):				796,36 €

Please transfer the open invoice amount until 05.01.2024 to the account stated below.
Terms of payment: 14 days net.

Cube GmbH
Kubus-Allee 234
20097 Hamburg

Telefon: +49 (0) 40 55 66 36 -0
Fax: +49 (0) 40 55 66 38 - 12
info@cube.de | www.cubealibaba.de
USt-Id: DE27556046

Leinweibbank Bank/Württemberg
IBAN: DE320505110002034304
BIC: SOLWDE33
Hauptgüter-Straße
IBAN: DE22056506110711393
BIC: WSLPDE33



No longer
readable by
humans



xSuite

Accounts Payable Invoice Automation
APIA



E-Network,
Portal

xSuite



E-Invoice by
E-Mail
PDF-Invoice by
E-Mail
Paper-Invoice by Mail

xSuite



Tax Authority (CTC)

xSuite

Local laws and obligations
european legislation, Peppol, EN 16931, standardized Formats, standardized Transport, ViDA



xSuite **e**lectronic **D**ocument **N**etwork **A**dapter

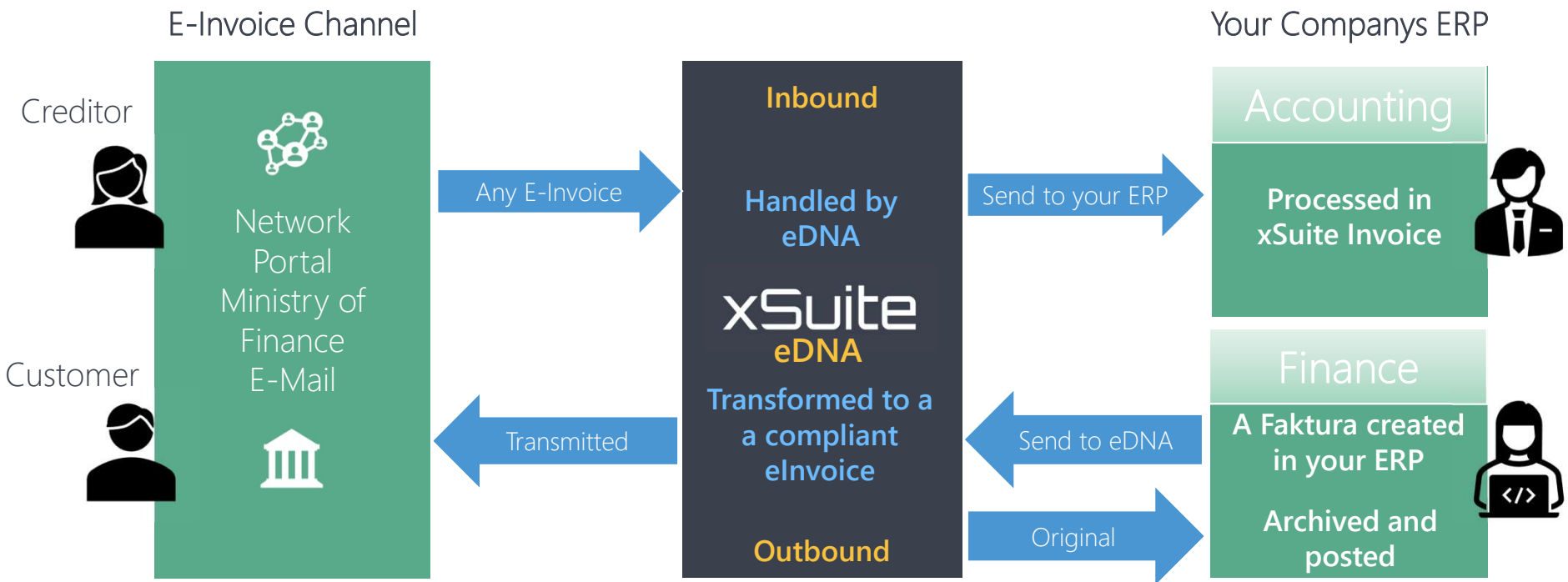

Global Compliance by ecosio



Inhouse Format ↔ ERPEL XML ↔ Legale E-Rechnung



Ecosio - ERP Integration

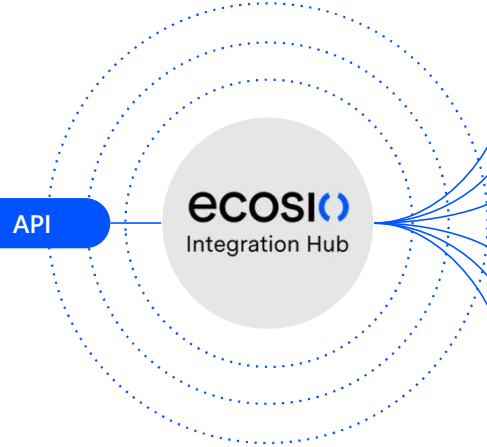

ecosio Integration Hub



Peppol + E-Invoice Portals



international Compliance

xSuite - ecosio - Partnership

xSuite Kunden profitieren von der globalen technischen Compliance

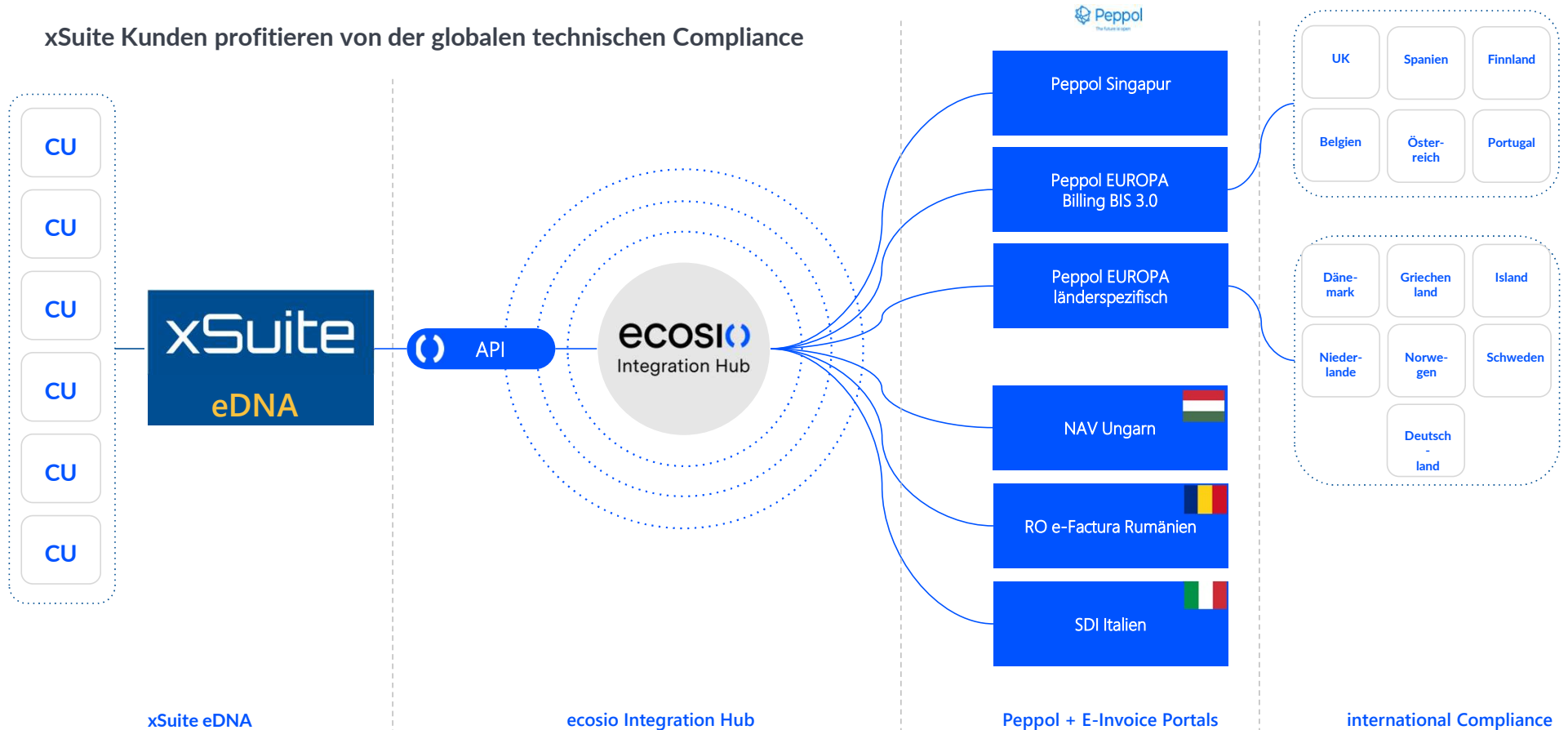

xSuite E-Invoicing Outbound

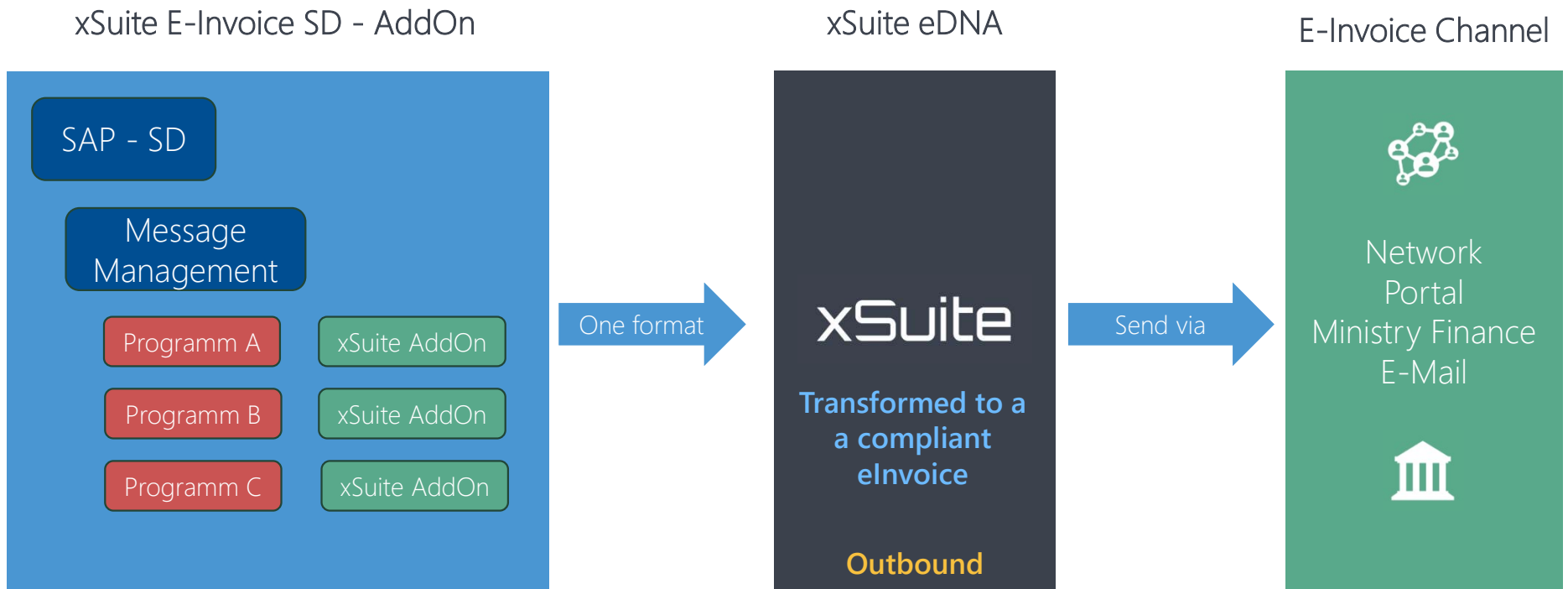

electronic Document Network Adapter

Platform Basics

- › Multi Tenant Public Cloud
- › Customer-tenant principle
- › LDAP integration
- › User and group administration
- › E-mail notifications for admins and users

Business Features

- › Invoice receipt book
- › Outgoing invoice ledger
- › User-specific reporting
- › Invoice detail view



electronic Document Network Adapter

Country support

- › **Peppol**: Austria, Germany, Finland, Belgium, Croatia, Denmark, Estonia, Netherlands, Norway, Poland, Sweden, UK, Australia, Cyprus, France, Ireland, (Japan), Luxembourg, (Malaysia), (Malta), New Zealand
- › **Peppol SG**: Singapore
- › **ANAF**: Rumänien
- › **SDI**: Italy

Compliance

- › Data integrity check
- › Format check §
- › Invoice data validation
- › Compliance with EN 16931
- › Peppol-certified invoice dispatch and receipt
- › Certified CTC portal connections



electronic Document Network Adapter

Pricing model

- › Onboarding
- › Subscription in document scales (for all entities)



xSuite eInvoicing Classic (OnPrem)

Further e-invoice processing options

- Any XML structures incoming/outgoing
- Peppol BIS Billing 3.0, ZUGFeRD, XRechnung incoming by e-mail

Connection of external service providers

- Storecove (Peppol AP)
- Storecove (CTC e.g Poland, Italy)
- DataPost Singapore (Peppol AP)
- ITZ-Bund and ZRE / Bundesdruckerei (B2G Germany)
- NRW state portal (B2g Germany)



xSuite e-Invoicing

...Inbound Outbound eDocument processing for SAP and AgnosticERP

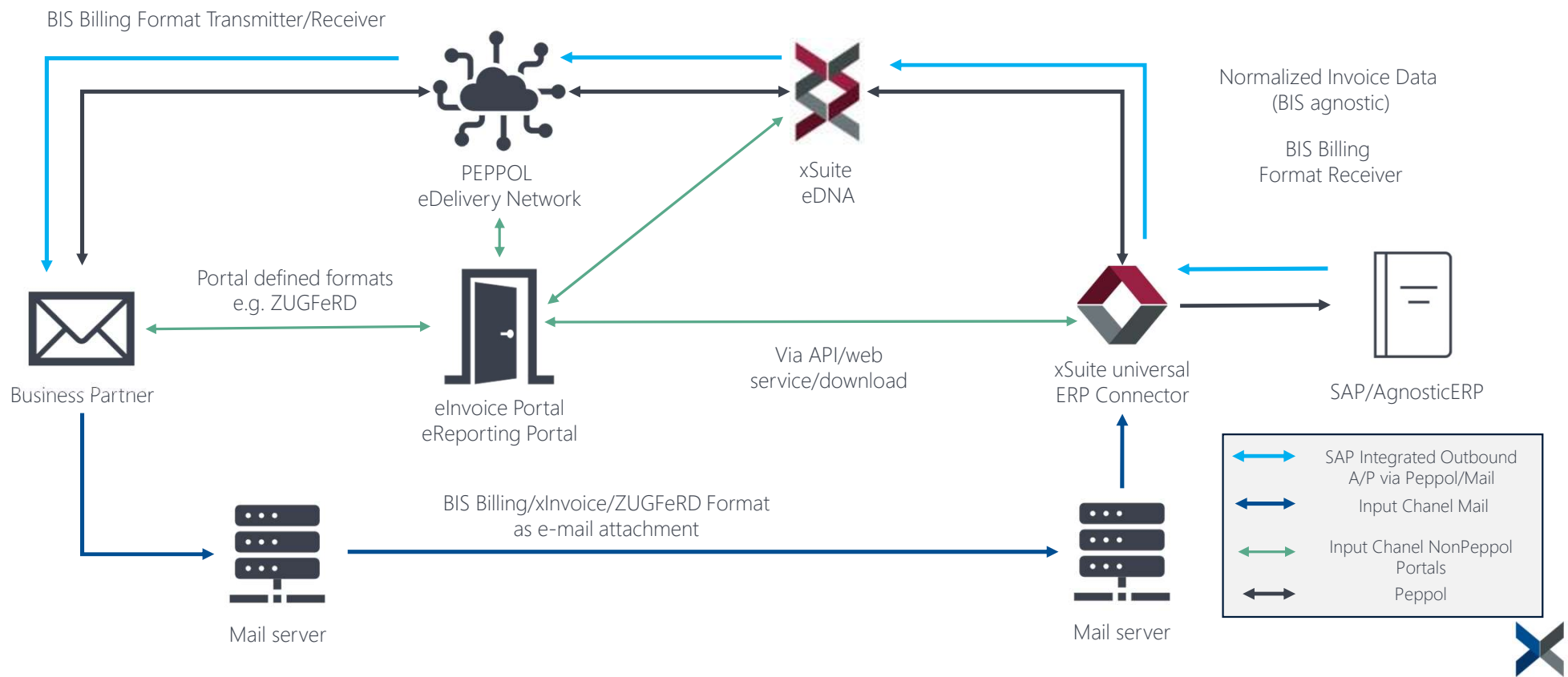

xSuite eDNA

Key-Benefits



xSuite eDNA

... your Process Accelerator

Savings in APIA process costs
due to reduced validation times



xSuite eDNA ...your legal advisor

You process your invoices

-

We guarantee their legal
validity for you



xSuite

... your partner for the future

...new obligations at a glance

...new formats available on time

...new portals available on time

...new networks available on time



xSuite eDNA

... your infrastructure reliever

Reduced hardware costs

Reduced software costs

Reduced IT personnel costs



Roadmap: xSuite eDNA



Q2 2024

- Go-Live eDNA



Q3/Q4 2024

- Outbound Invoices SAP ERP (Network, E-Mail)
- Helix / SAP BTP Connection (inbound)
- Inbound Invoices (E-Mail)
- Further Networks (\$,\$)



2025 / 2026

- Further Countrys (\$,\$)
- Further Portals (\$,\$)
- Digital singantures
- Centralized Digital Post Office



Do you have any questions?

- ▶ Feel free to contact us at any time!
- ▶ Your speaker was Sven Holtmann, Product Manager at xSuite
sales@xsuite.com

